

# NOVA Cutting

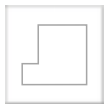

Grooving



Rebating



Profiling

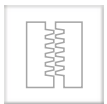

Jointing



Frame &  
Panel door

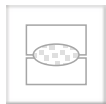

Lamello



**Multi Profile  
system**

## Multi Profile System Cutter

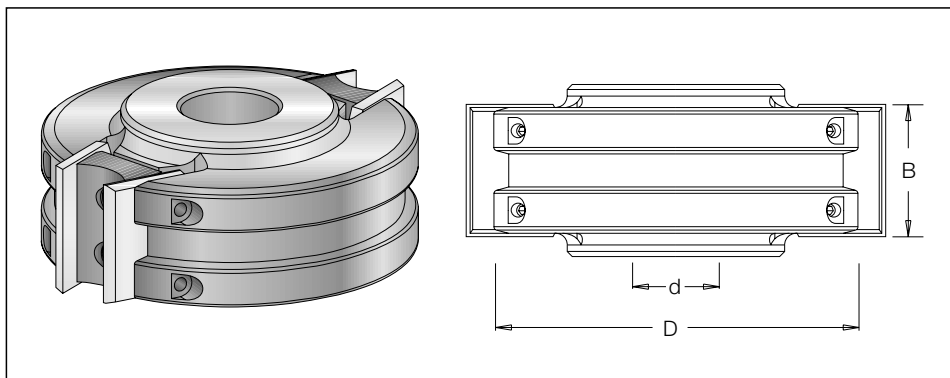

$\varnothing D$	B	Code No.	Teeth	$\varnothing d$	n
93	40	776 006 1	2	30	6,000 - 9,000
120	40	776 007 1	2	30	5,100 - 7,900
114	40/50	776 008 1	2	30	5,000 - 8,000

### Spare parts:



Knife

#331 914 0  
40x20x4



Limiter

#341 914 0  
38x19x4



Wedge

#199 801 0  
L = 38



Allen screw

#193 026 6  
M8x12



Allen key

#194 003 6  
S4

## Multi Profile System - 40mm

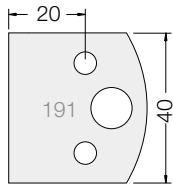

Kn 33 191 40  
Li 34 191 40

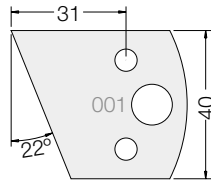
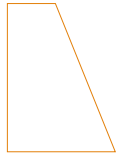

Kn 33 001 40  
Li 34 001 40

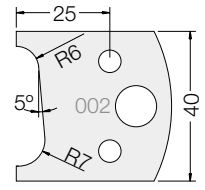

Kn 33 002 40  
Li 34 002 40

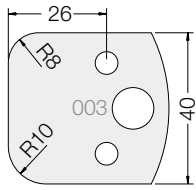

Kn 33 003 40  
Li 34 003 40

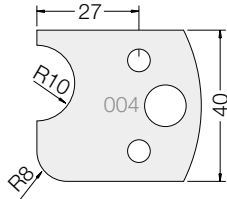

Kn 33 004 40  
Li 34 004 40

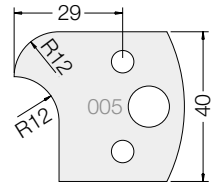

Kn 33 005 40  
Li 34 005 40

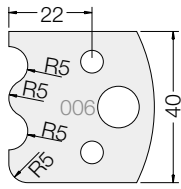

Kn 33 006 40  
Li 34 006 40

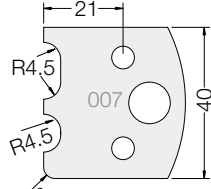

Kn 33 007 40  
Li 34 007 40

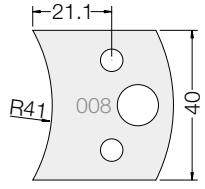

Kn 33 008 40  
Li 34 008 40

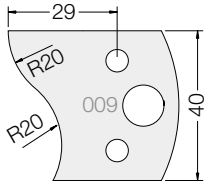
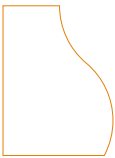

Kn 33 009 40  
Li 34 009 40

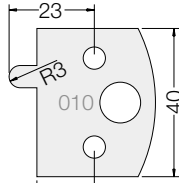
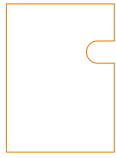

Kn 33 010 40  
Li 34 010 40

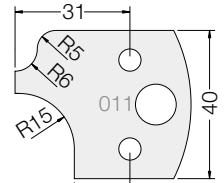

Kn 33 011 40  
Li 34 011 40

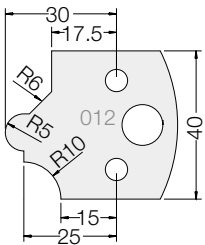
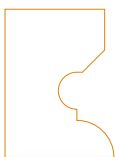

Kn 33 012 40  
Li 34 012 40

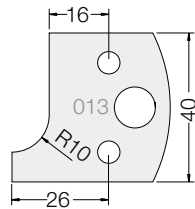
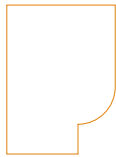

Kn 33 013 40  
Li 34 013 40

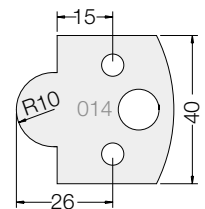

Kn 33 014 40  
Li 34 014 40

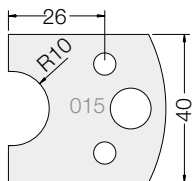

Kn 33 015 40  
Li 34 015 40

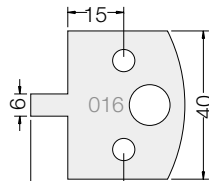

Kn 33 016 40  
Li 34 016 40

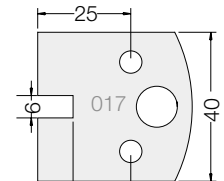
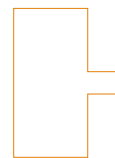

Kn 33 017 40  
Li 34 017 40

## Multi Profile System - 40mm

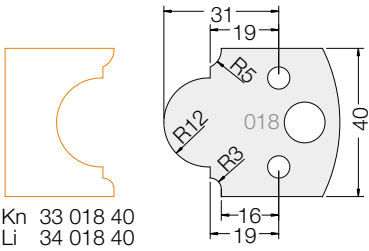

Kn 33 018 40  
Li 34 018 40

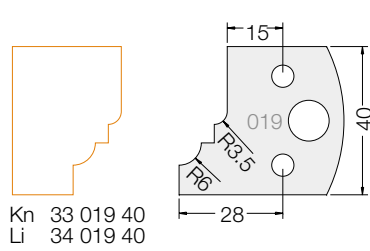

Kn 33 019 40  
Li 34 019 40

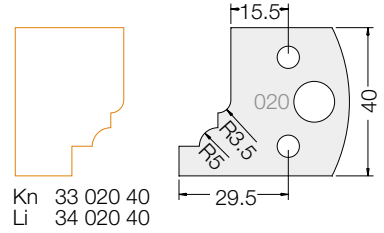

Kn 33 020 40  
Li 34 020 40

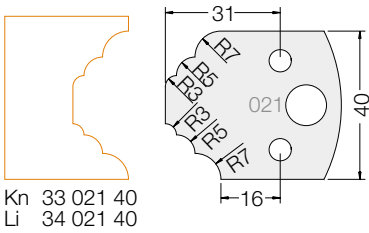

Kn 33 021 40  
Li 34 021 40

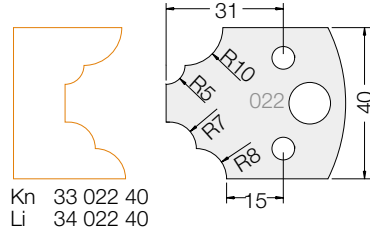

Kn 33 022 40  
Li 34 022 40

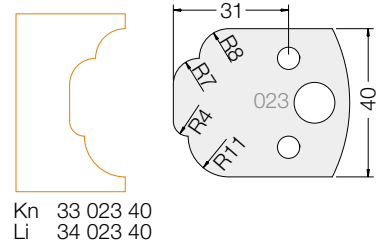

Kn 33 023 40  
Li 34 023 40

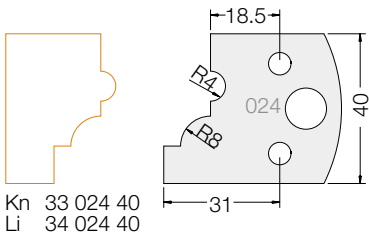

Kn 33 024 40  
Li 34 024 40

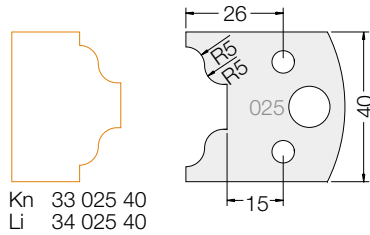

Kn 33 025 40  
Li 34 025 40

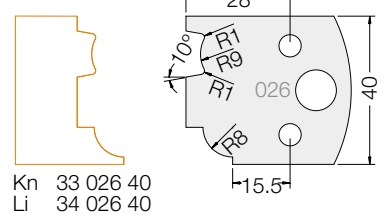

Kn 33 026 40  
Li 34 026 40

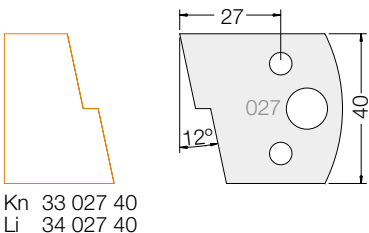

Kn 33 027 40  
Li 34 027 40

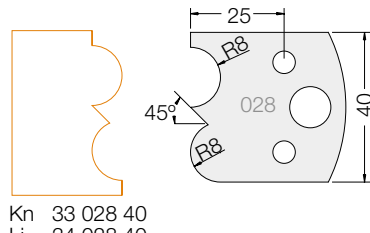

Kn 33 028 40  
Li 34 028 40

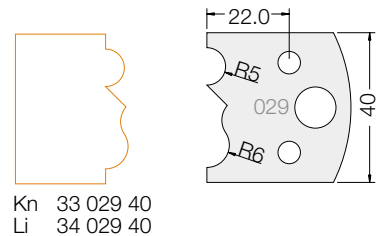

Kn 33 029 40  
Li 34 029 40

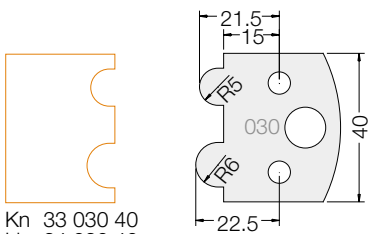

Kn 33 030 40  
Li 34 030 40

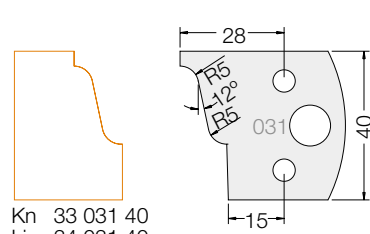

Kn 33 031 40  
Li 34 031 40

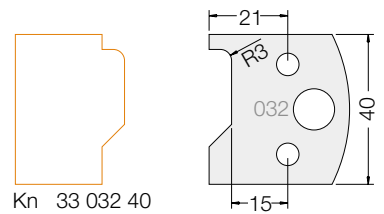

Kn 33 032 40  
Li 34 032 40

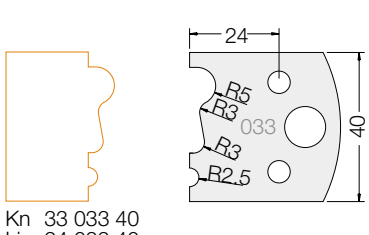

Kn 33 033 40  
Li 34 033 40

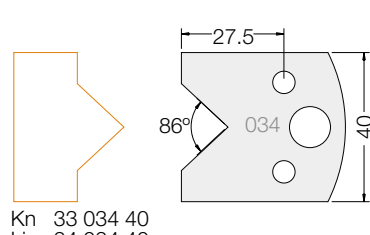

Kn 33 034 40  
Li 34 034 40

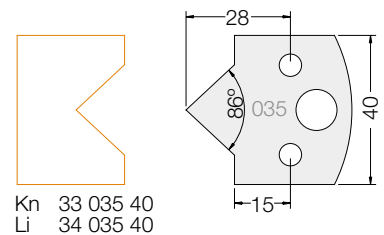

Kn 33 035 40  
Li 34 035 40

## Multi Profile System - 40mm

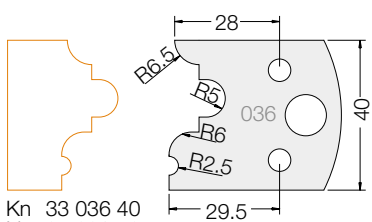

Kn 33 036 40  
Li 34 036 40

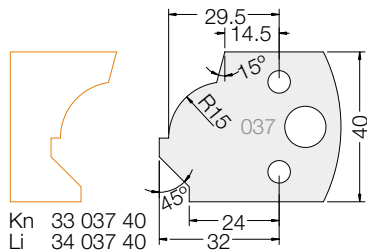

Kn 33 037 40  
Li 34 037 40

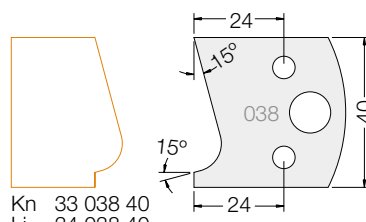

Kn 33 038 40  
Li 34 038 40

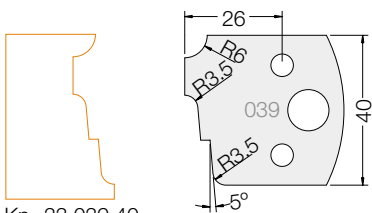

Kn 33 039 40  
Li 34 039 40

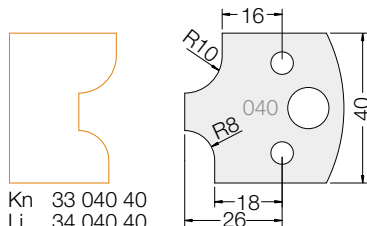

Kn 33 040 40  
Li 34 040 40

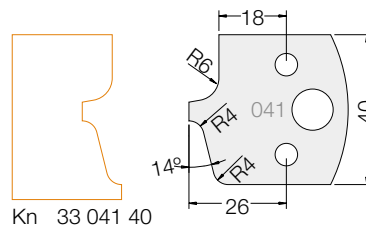

Kn 33 041 40  
Li 34 041 40

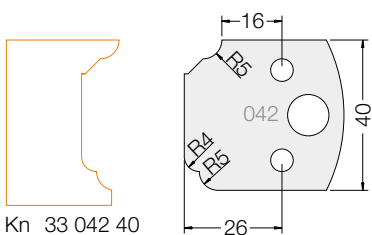

Kn 33 042 40  
Li 34 042 40

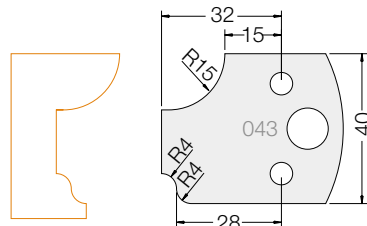

Kn 33 043 40  
Li 34 043 40

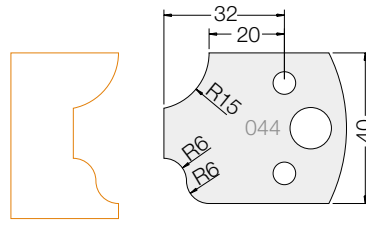

Kn 33 044 40  
Li 34 044 40

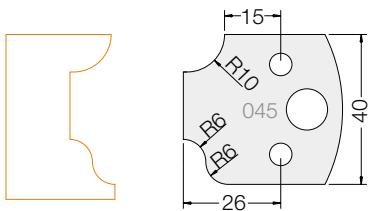

Kn 33 045 40  
Li 34 045 40

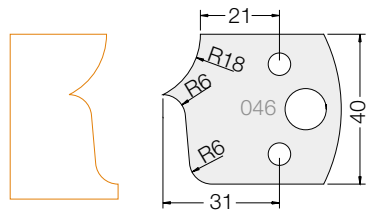

Kn 33 046 40  
Li 34 046 40

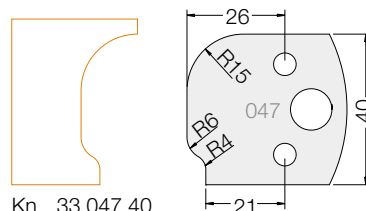

Kn 33 047 40  
Li 34 047 40

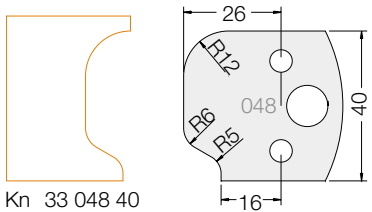

Kn 33 048 40  
Li 34 048 40

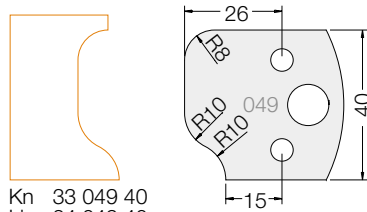

Kn 33 049 40  
Li 34 049 40

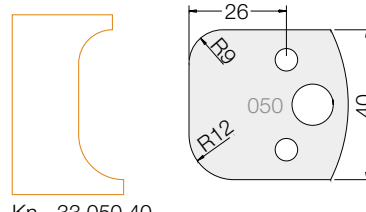

Kn 33 050 40  
Li 34 050 40

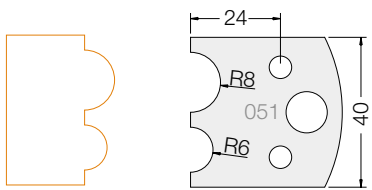

Kn 33 051 40  
Li 34 051 40

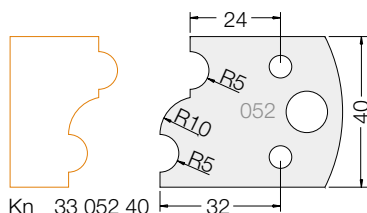

Kn 33 052 40  
Li 34 052 40

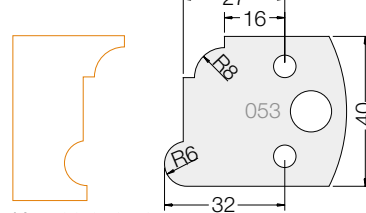

Kn 33 053 40  
Li 34 053 40

## Multi Profile System - 40mm

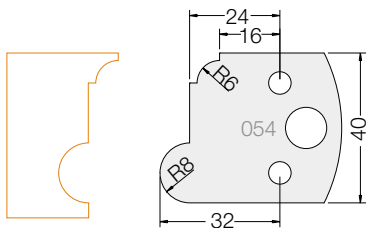

Kn 33 054 40  
Li 34 054 40

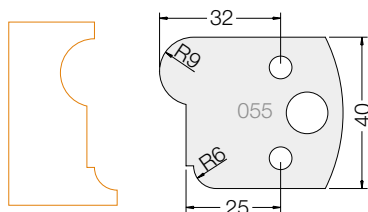

Kn 33 055 40  
Li 34 055 40

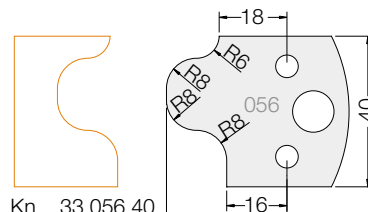

Kn 33 056 40  
Li 34 056 40

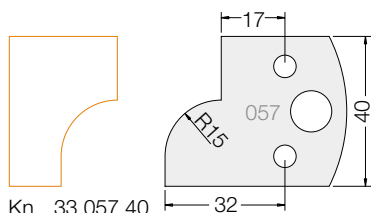

Kn 33 057 40  
Li 34 057 40

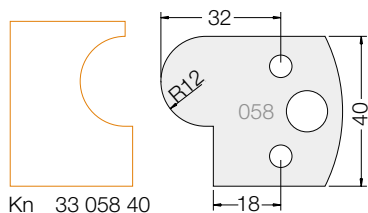

Kn 33 058 40  
Li 34 058 40

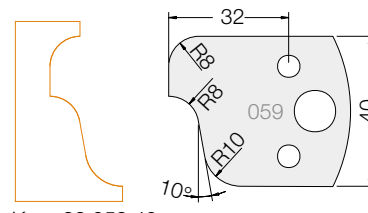

Kn 33 059 40  
Li 34 059 40

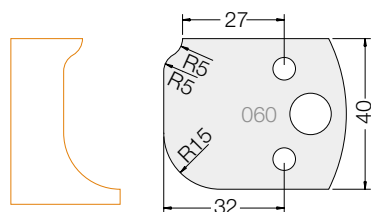

Kn 33 060 40  
Li 34 060 40

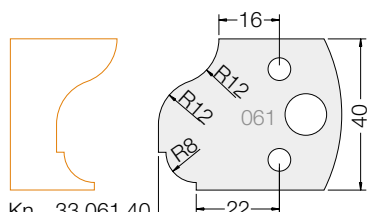

Kn 33 061 40  
Li 34 061 40

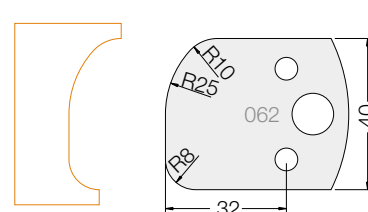

Kn 33 062 40  
Li 34 062 40

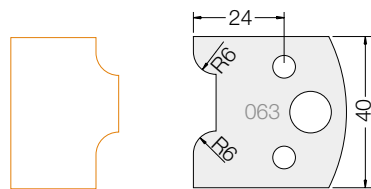

Kn 33 063 40  
Li 34 063 40

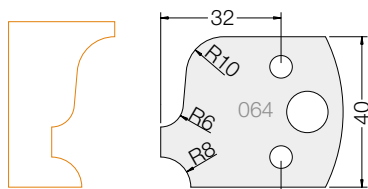

Kn 33 064 40  
Li 34 064 40

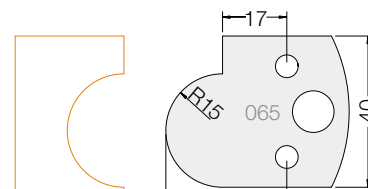

Kn 33 065 40  
Li 34 065 40

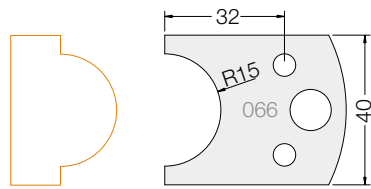

Kn 33 066 40  
Li 34 066 40

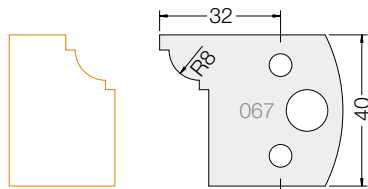

Kn 33 067 40  
Li 34 067 40

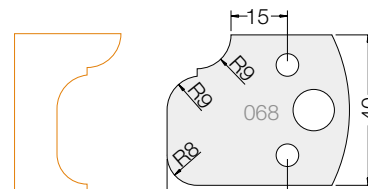

Kn 33 068 40  
Li 34 068 40

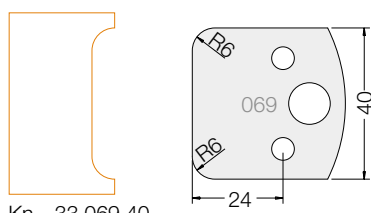

Kn 33 069 40  
Li 34 069 40

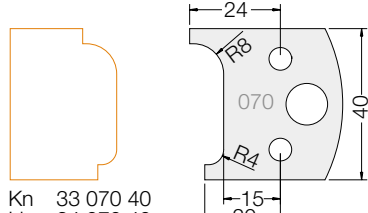

Kn 33 070 40  
Li 34 070 40

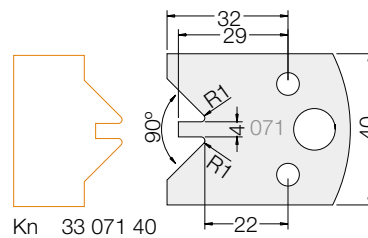

Kn 33 071 40  
Li 34 071 40

## Multi Profile System - 40mm

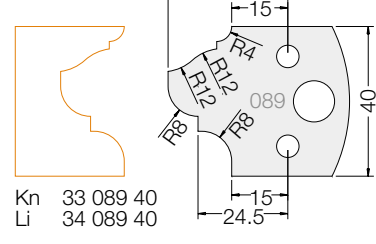
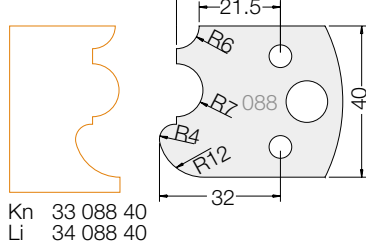
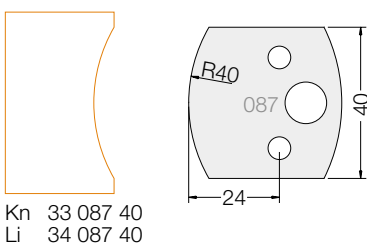
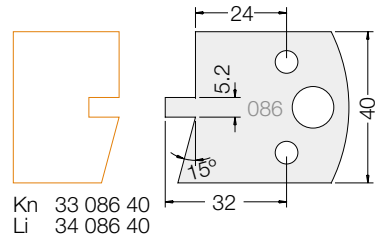
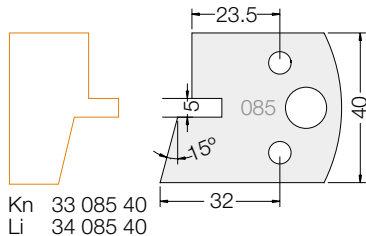
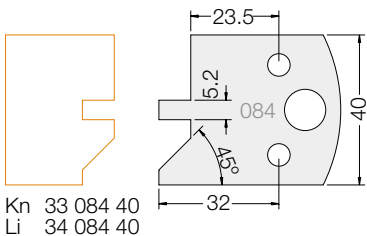
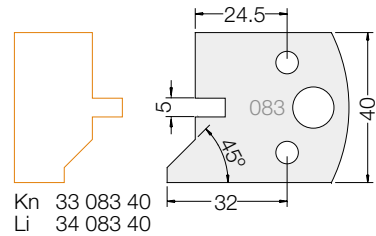
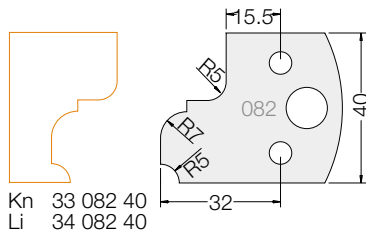
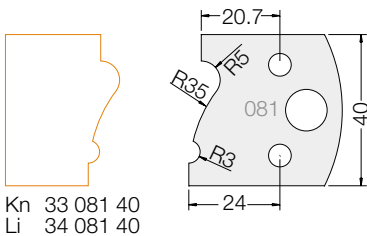
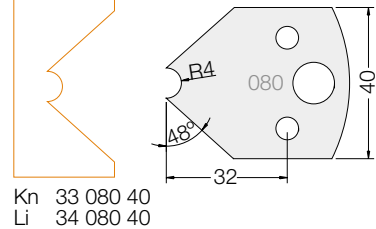
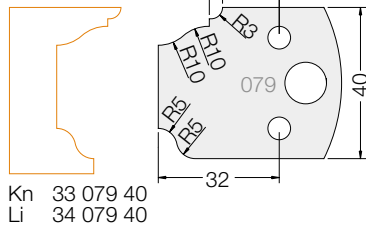
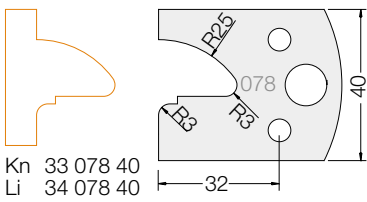
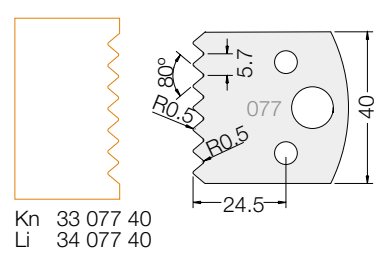
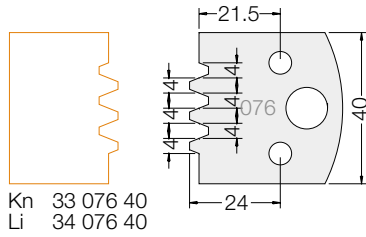
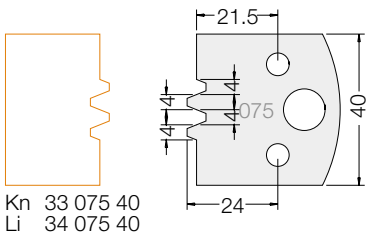
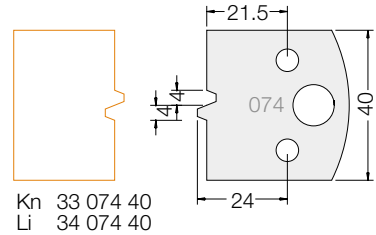
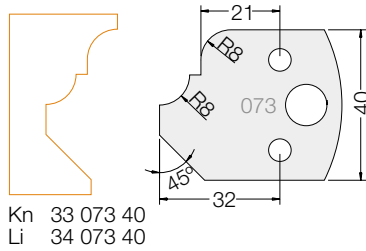
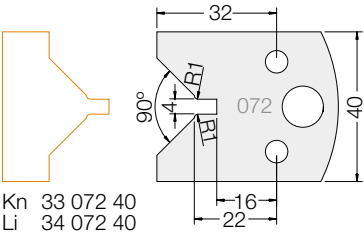

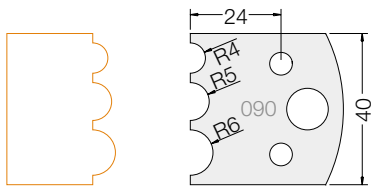

Kn 33 090 40  
Li 34 090 40

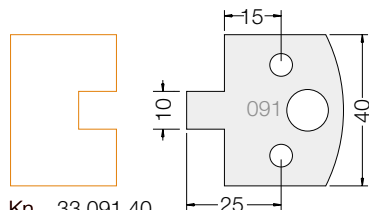

Kn 33 091 40  
Li 34 091 40

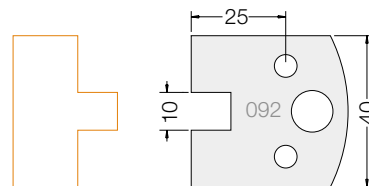

Kn 33 092 40  
Li 34 092 40

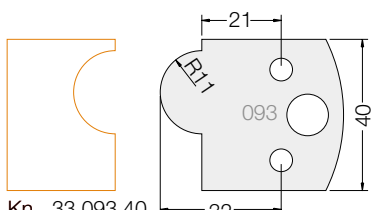

Kn 33 093 40  
Li 34 093 40

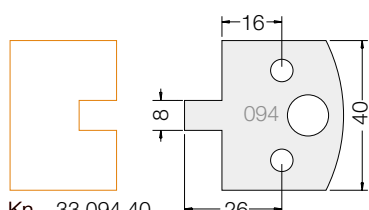

Kn 33 094 40  
Li 34 094 40

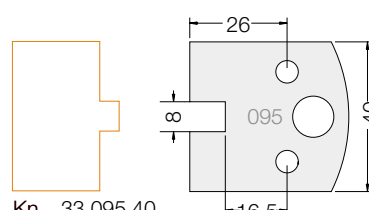

Kn 33 095 40  
Li 34 095 40

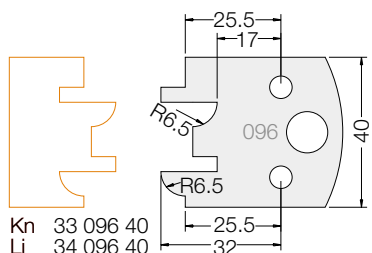

Kn 33 096 40  
Li 34 096 40

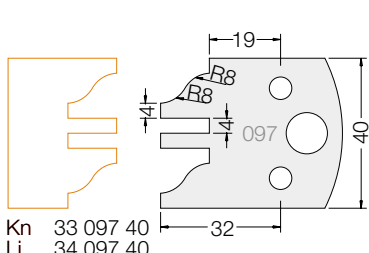

Kn 33 097 40  
Li 34 097 40

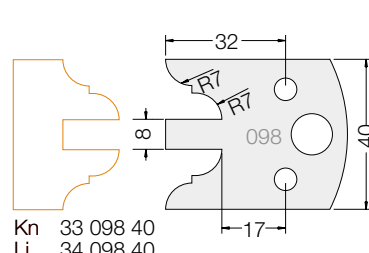

Kn 33 098 40  
Li 34 098 40

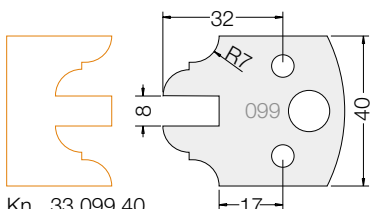

Kn 33 099 40  
Li 34 099 40

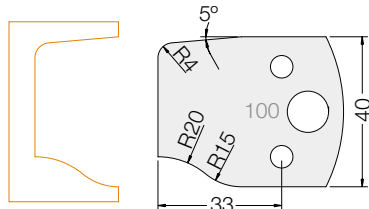

Kn 33 100 40  
Li 34 100 40

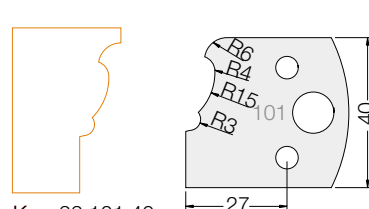

Kn 33 101 40  
Li 34 101 40

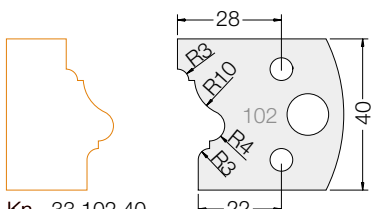

Kn 33 102 40  
Li 34 102 40

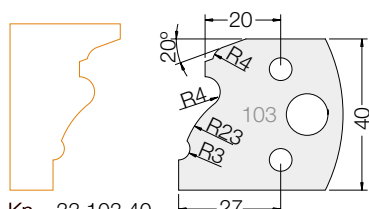

Kn 33 103 40  
Li 34 103 40

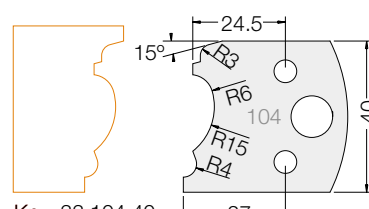

Kn 33 104 40  
Li 34 104 40

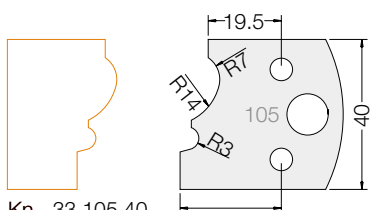

Kn 33 105 40  
Li 34 105 40

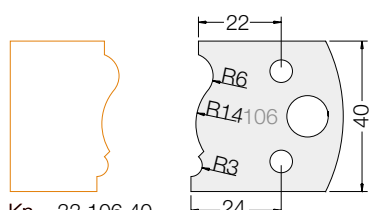

Kn 33 106 40  
Li 34 106 40

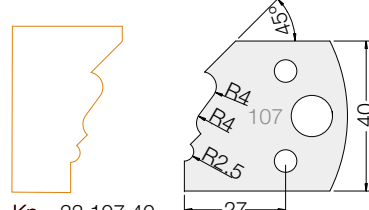

Kn 33 107 40  
Li 34 107 40

## Multi Profile System - 40mm

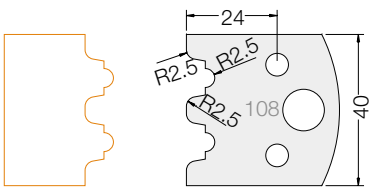

Kn 33 108 40  
Li 34 108 40

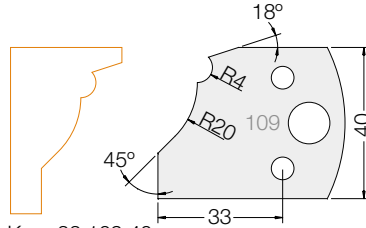

Kn 33 109 40  
Li 34 109 40

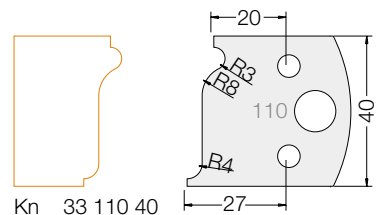

Kn 33 110 40  
Li 34 110 40

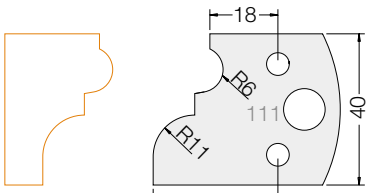

Kn 33 111 40  
Li 34 111 40

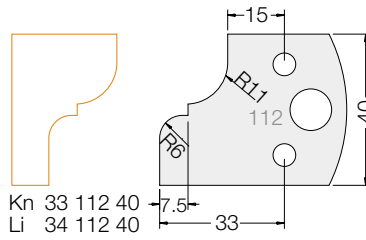

Kn 33 112 40  
Li 34 112 40

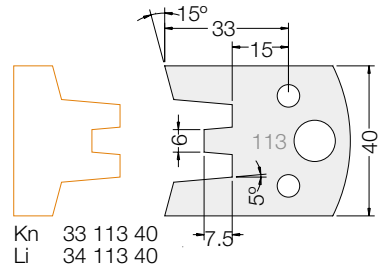

Kn 33 113 40  
Li 34 113 40

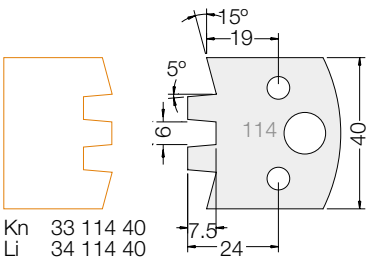

Kn 33 114 40  
Li 34 114 40

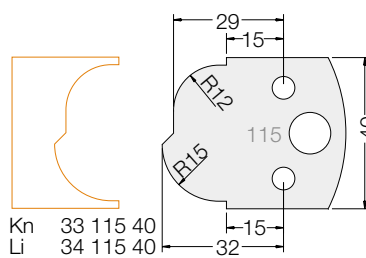

Kn 33 115 40  
Li 34 115 40

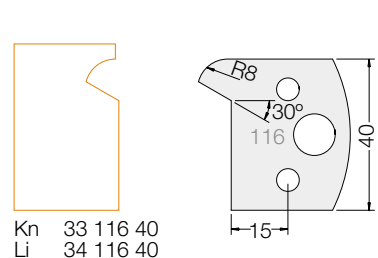

Kn 33 116 40  
Li 34 116 40

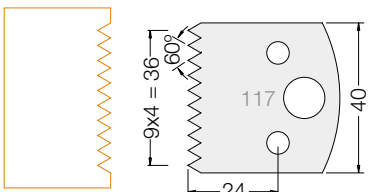

Kn 33 117 40  
Li 34 117 40

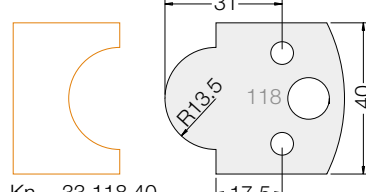

Kn 33 118 40  
Li 34 118 40

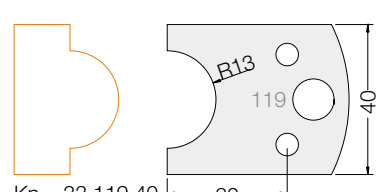

Kn 33 119 40  
Li 34 119 40

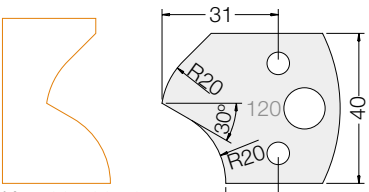

Kn 33 120 40  
Li 34 120 40

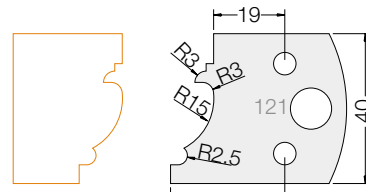

Kn 33 121 40  
Li 34 121 40

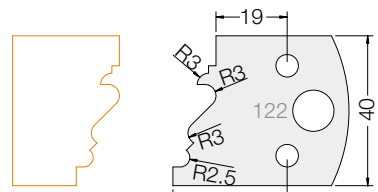

Kn 33 122 40  
Li 34 122 40

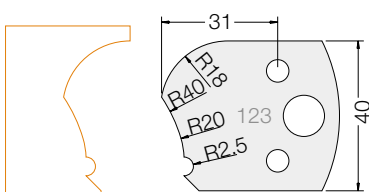

Kn 33 123 40  
Li 34 123 40

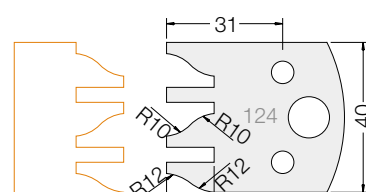

Kn 33 124 40  
Li 34 124 40

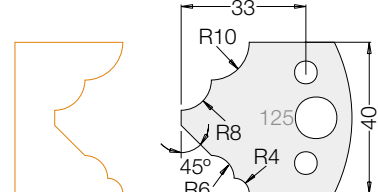

Kn 33 125 40  
Li 34 125 40



## Multi Profile System - 40mm

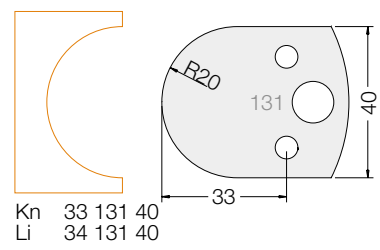
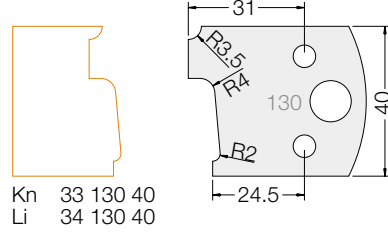
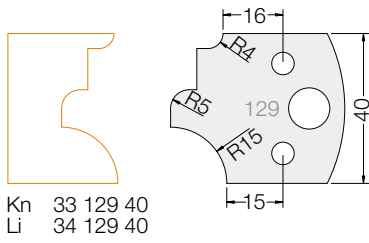
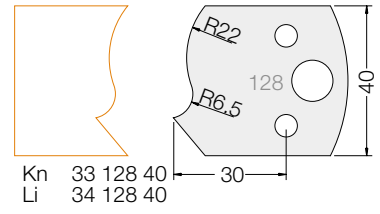
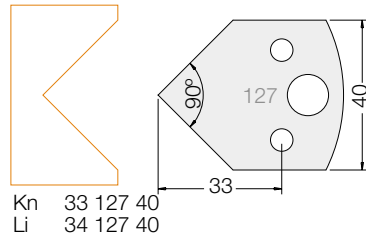
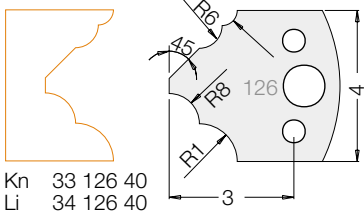

## Multi Profile System - 50mm

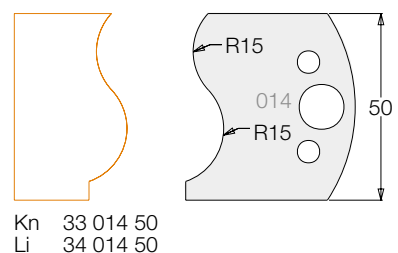
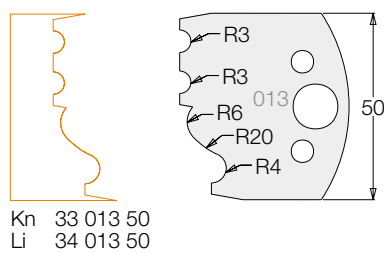
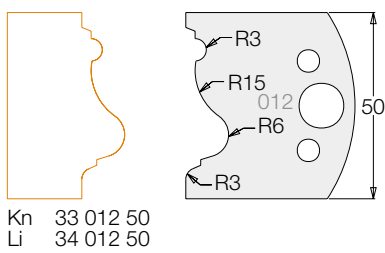
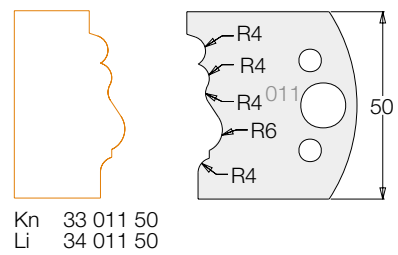
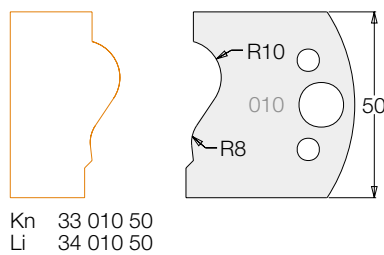
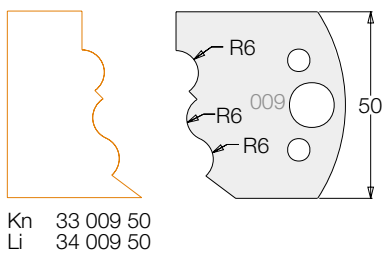
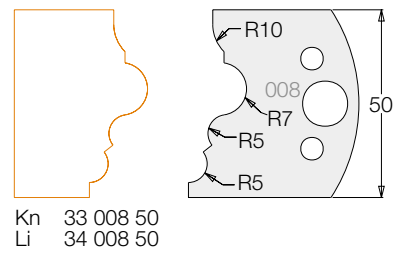
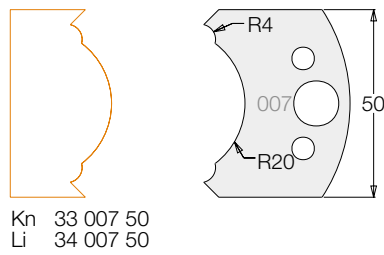
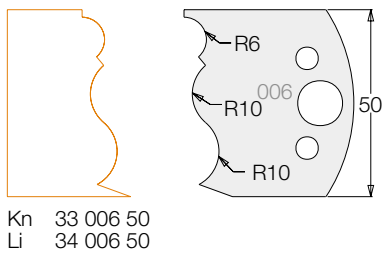
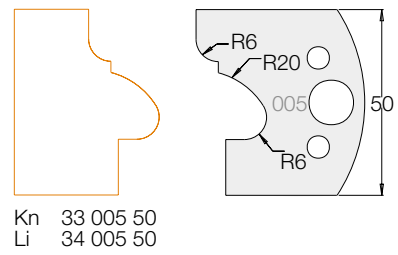
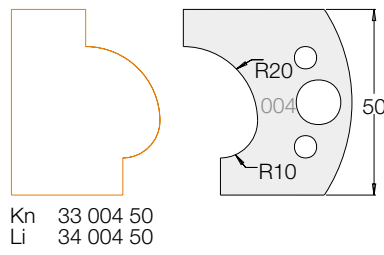
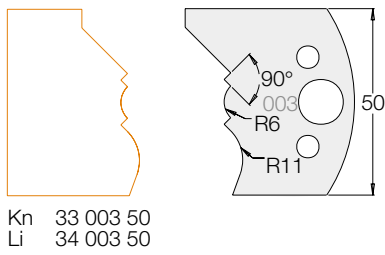
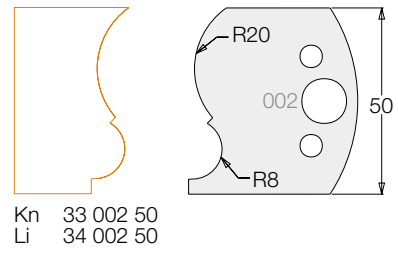
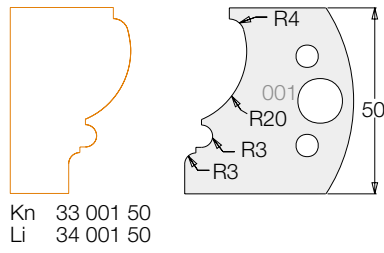
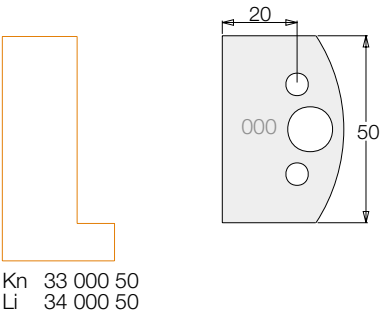

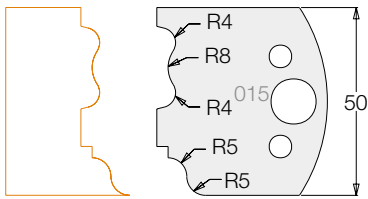

Kn 33 015 50  
Li 34 015 50

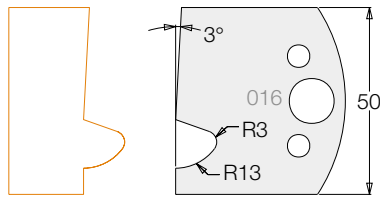

Kn 33 016 50  
Li 34 016 50

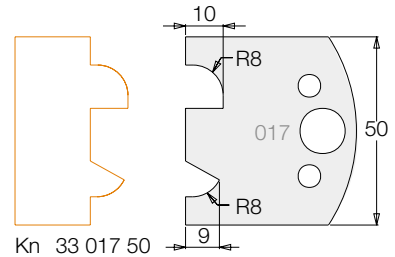

Kn 33 017 50  
Li 34 017 50

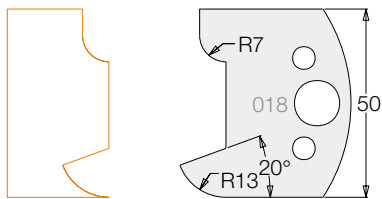

Kn 33 018 50  
Li 34 018 50

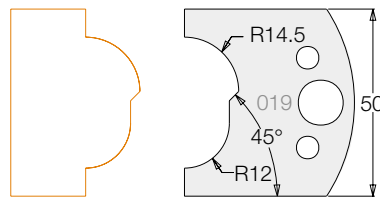

Kn 33 019 50  
Li 34 019 50

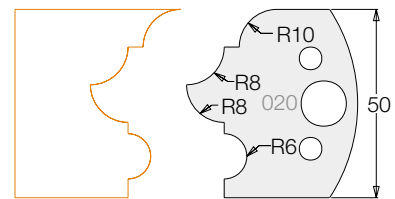

Kn 33 020 50  
Li 34 020 50

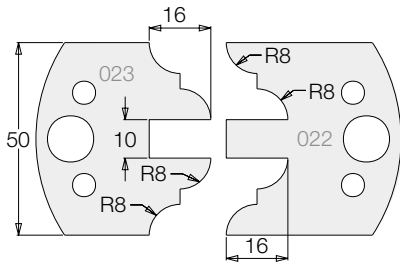

Kn 33 023 50  
Li 34 023 50

Kn 33 022 50  
Li 34 022 50

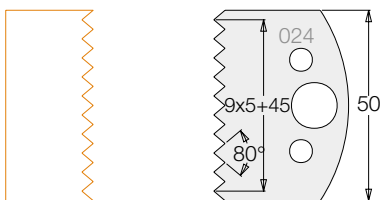

Kn 33 024 50  
Li 34 024 50

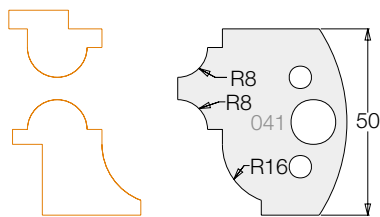

Kn 33 041 50  
Li 34 041 50

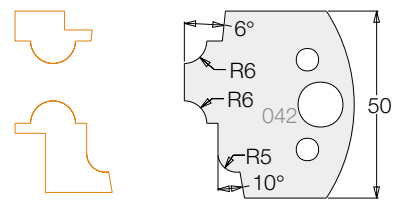

Kn 33 042 50  
Li 34 042 50

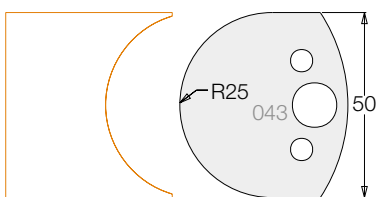

Kn 33 043 50  
Li 34 043 50

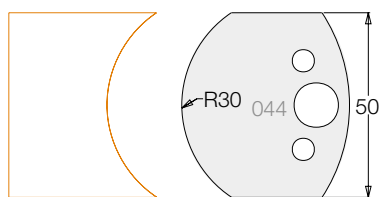

Kn 33 044 50  
Li 34 044 50

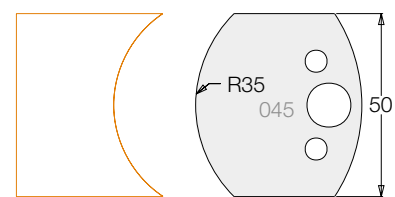

Kn 33 045 50  
Li 34 045 50

## Multi Profile System - 50mm

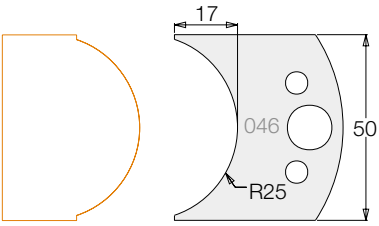

Kn 33 046 50  
Li 34 046 50

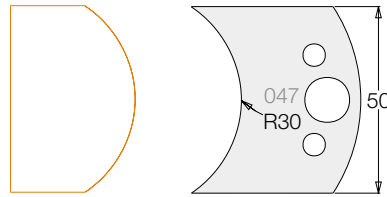

Kn 33 047 50  
Li 34 047 50

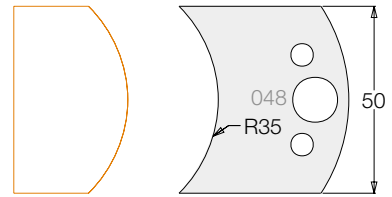

Kn 33 048 50  
Li 34 048 50

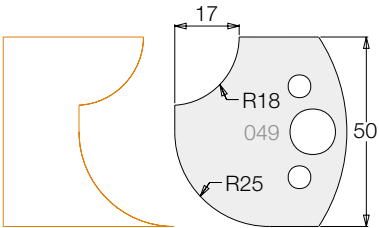

Kn 33 049 50  
Li 34 049 50

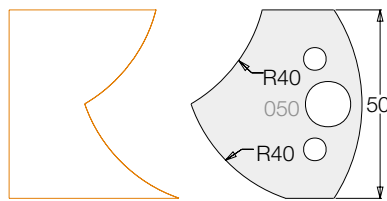

Kn 33 050 50  
Li 34 050 50

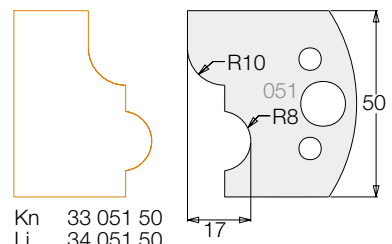

Kn 33 051 50  
Li 34 051 50

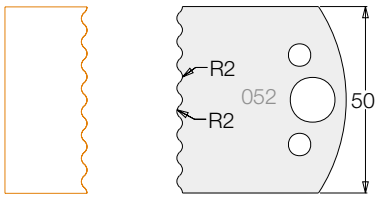

Kn 33 052 50  
Li 34 052 50

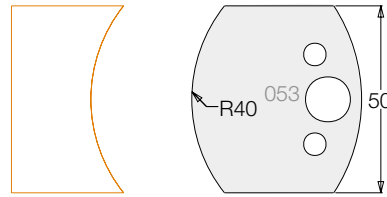

Kn 33 053 50  
Li 34 053 50

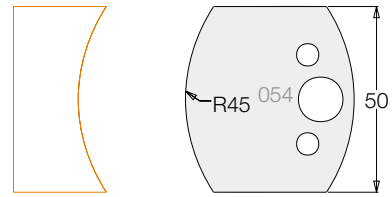

Kn 33 054 50  
Li 34 054 50

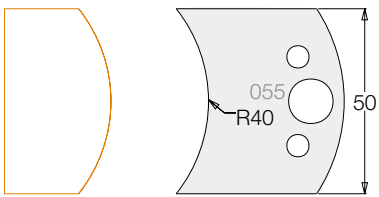

Kn 33 055 50  
Li 34 055 50

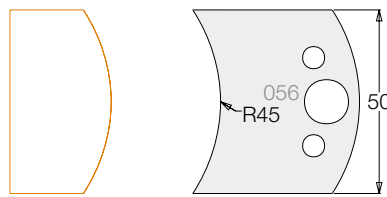

Kn 33 056 50  
Li 34 056 50

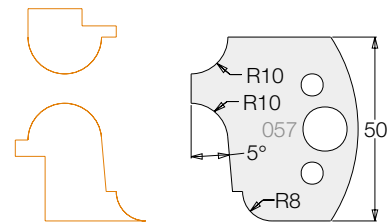

Kn 33 057 50  
Li 34 057 50

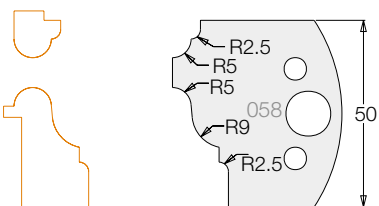

Kn 33 058 50  
Li 34 058 50

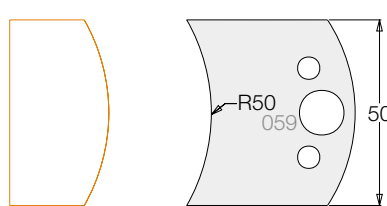

Kn 33 059 50  
Li 34 059 50

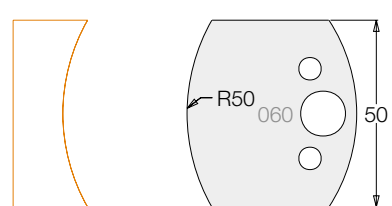

Kn 33 060 50  
Li 34 060 50

## Multi Profile System - 50mm

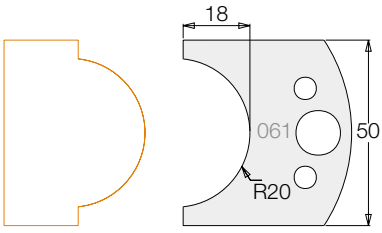

Kn 33 061 50  
Li 34 061 50

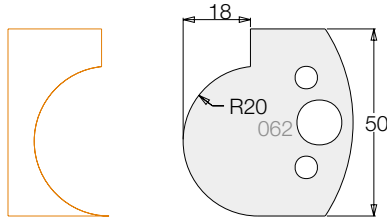

Kn 33 062 50  
Li 34 062 50

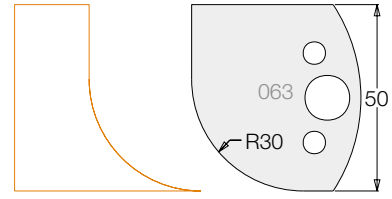

Kn 33 063 50  
Li 34 063 50

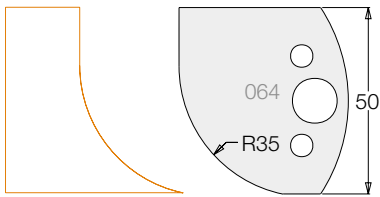

Kn 33 064 50  
Li 34 064 50

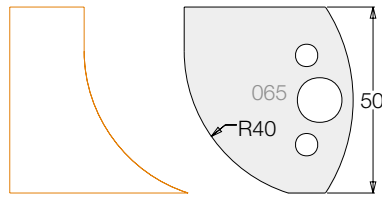

Kn 33 065 50  
Li 34 065 50

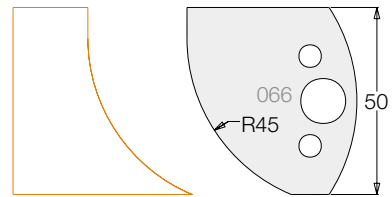

Kn 33 066 50  
Li 34 066 50

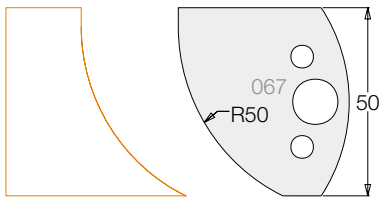

Kn 33 067 50  
Li 34 067 50

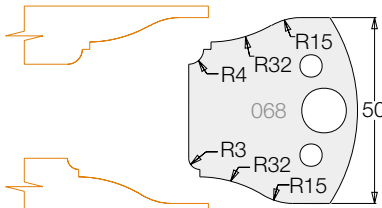

Kn 33 068 50  
Li 34 068 50

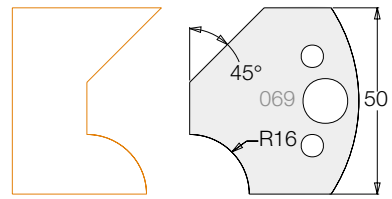

Kn 33 069 50  
Li 34 069 50